

bench systems

The latest desking solution, the bench system provides a large expanse of workspace with a continuous, uninterrupted surface area. A great idea with flexibility built in for larger teams that need to work together.

Benches are 800mm x 740mm high and are available in a wide range of widths from 1m to 2m. Bench tops slide forward for easy access to the cable management system.

single bench

Cable tray available as an additional extra

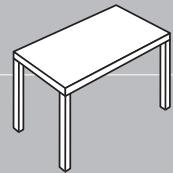

double bench system

Includes one cable tray

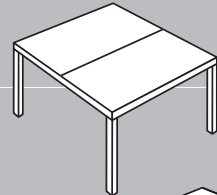

4 bench system

Includes two cable trays

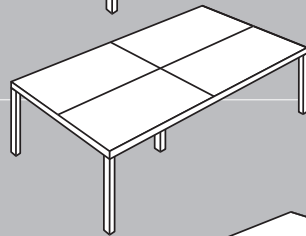

6 bench system

Includes 3 cable trays

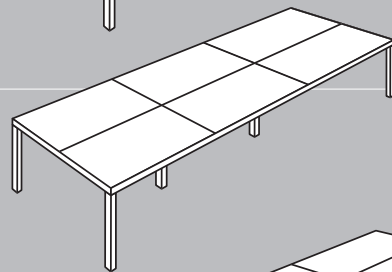

8 bench system

Includes 4 cable trays

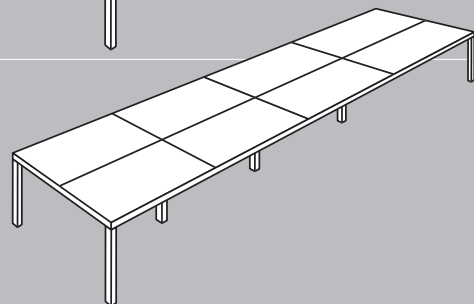

sizes options (mm):

Single bench	800 x	1000	1200	1400	1600	1800	2000
Double bench system	1600 x	1000	1200	1400	1600	1800	2000
4 bench system	1600 x	2000	2400	2800	3200	3600	4000
6 bench system	1600 x	3000	3600	4200	4800	5400	6000
8 bench system	1600 x	4000	4800	5600	6400	7200	8000

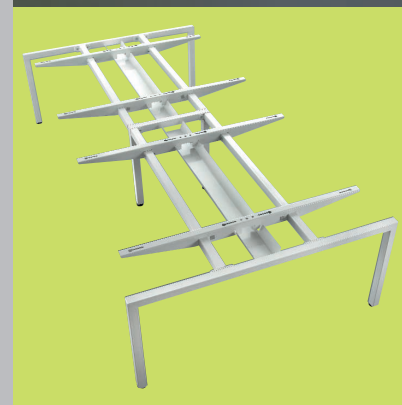

Our bench systems have a sturdy steel frame and come in striking silver, black, grey or white finish options.

Our bench systems are available with an innovative cable management system and a choice of screening options (see overleaf).

Bench tops are 25mm thick and come in all of these finishes so you can create just the look you want.

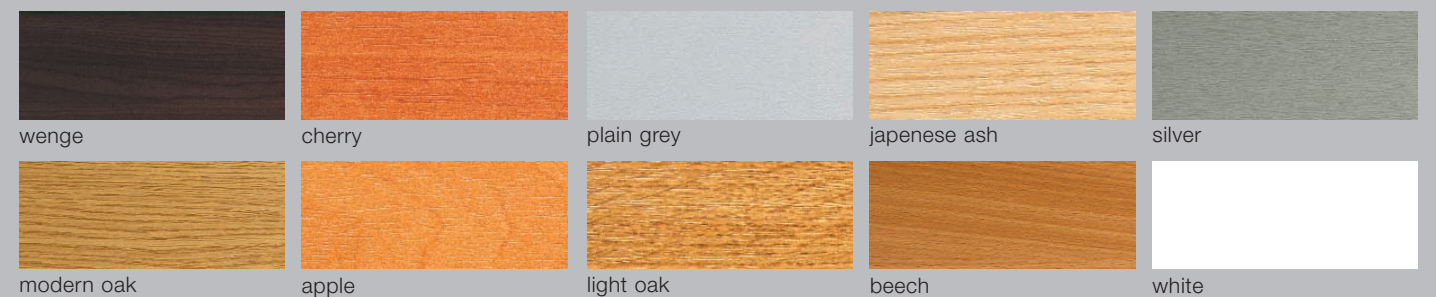

screens

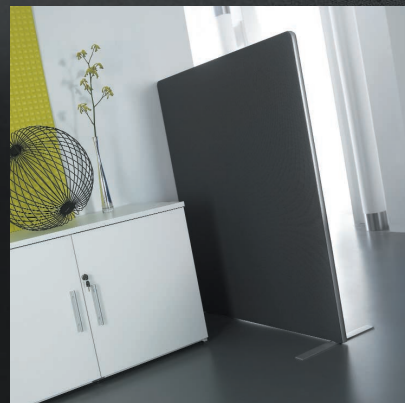

Floorstanding screens are a great way to divide your room space or hide away unsightly equipment.

The perfect complement to our new bench systems, our desk and floorstanding screens come in a choice of shapes, sizes and finishes with Grey, Silver or Maple edging as standard. Pinnable or linking options, extra deep brackets and luxury fabrics are all available as additional extras.

desk screens



wave

Width:
options ranging from
800mm – 1800mm

Height:
480mm to 280mm



rectangular

Width:
options ranging from
800mm – 1800mm

Height:
480mm



arc

Width:
options ranging from
800mm – 1800mm

Height:
480mm to 280mm

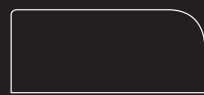

curved

Width:
options ranging from
800mm – 1800mm

Height:
480mm

floorstanding screens



straight

Width:
options ranging
from 1m – 1.8m

Height:
options ranging
from 1m – 1.8m



curved

Width:
800mm

Height:
options ranging
from 1m – 1.8m

For full details of sizes please see our seating, bench systems and screens price list.

accessories

The right accessories can make the difference between a good workspace and a great workspace. Designed for both style and function, our innovative ranges feature some great finishing touches to personalise your office and help keep it organised.



Our bench systems come complete with a innovative cable management system. The bench top simply slides forward for easy access to the cable tray.



You can use a pedestal unit with a bench system for flexible storage. This Metal Pedestal Unit has a sleek bow fronted design and comes with a choice of top finish.



We have a range of wire management accessories like this stylish Umbilical Spine Cable Tidy specially designed to help you keep trailing cables under control.



Plan storage into your office design and keep space working efficiently. We have a wide range of storage options from simple Base Units (shown above) to complete filing systems.